



Revoria Press E1 Series

PRODUCT BROCHURE



Advanced, high quality monochrome print production

Revoria E1 Series

A versatile and advanced range of printers designed to produce the highest quality monochrome print, consistently and reliably, at speeds of up to 136 ppm.

The E1 Series is capable of continuous operation, and with a wide variety of feeding and finishing options, will deliver a huge range of high quality finished print.



High productivity, reliable production

Ultra-high core print speeds of up to 136ppm

High-speed continuous printing of up to 136 ppm*1 has been made possible for both single and double sided jobs. This is because the advanced EA-Eco LGK toner allows fusing at lower temperatures, with a roll type fusing unit providing a consistent heat supply, resulting in the reliable fusing of paper transported at high speeds.

136
ppm

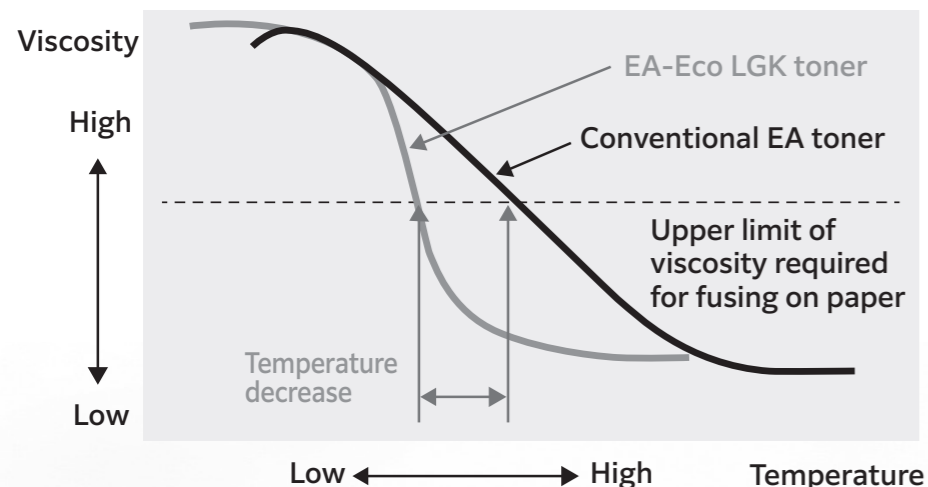

Advanced features that minimise paper jams are designed to ensure continuous operation

Stable paper transport

Wide turning angles in the paper path mean that the paper transport is fast and stable. In addition, for 2 sided printing, a vertical paper inversion mechanism reduces curves in the paper path to minimise paper jams. Finally, as the EA-Eco LGK toner fuses at lower temperatures, less impact is caused by the heat generated by the fused paper on the transfer mechanism, minimising paper transport issues.

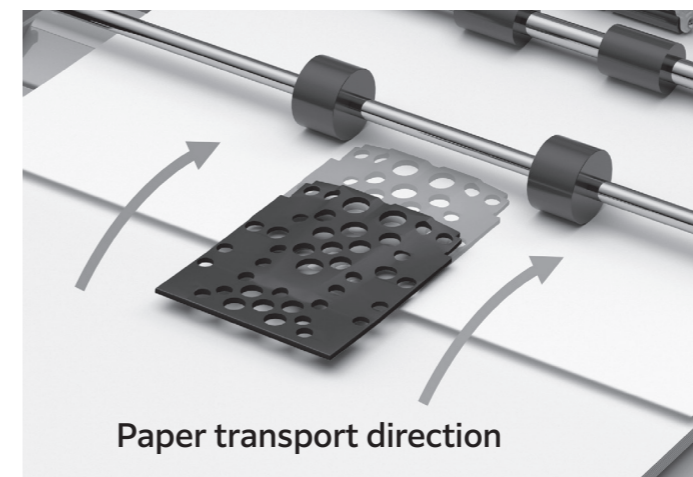
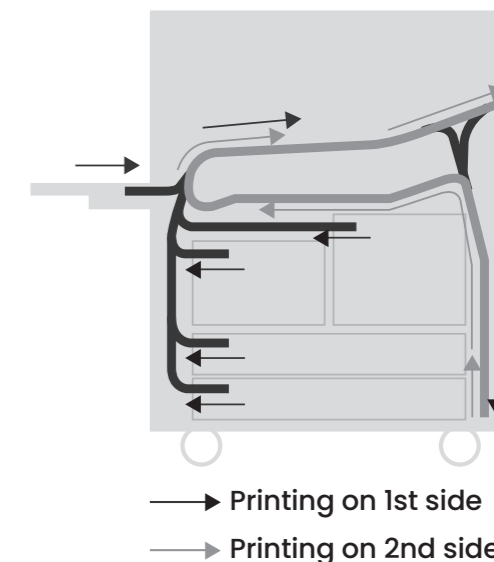

Air suction feeder with enhanced paper handling capabilities

The air suction feeder uses a small amount of air to easily separate and deliver each sheet efficiently. This improves the feed performance of many types of paper, for example paper with a lot of dust, pre-printed paper using powder, paper with an uneven texture, and coated paper that is prone to sticking. In addition, a stable feed is achieved at high speeds for various paper weights, from light to heavyweight, and from small sizes to large.



Continuous mass printing

High capacity feeders and stackers make continuous mass printing possible. In addition, cartridge replacement and paper refills can be done while printing is in progress, with a single high capacity toner cartridge yielding approximately 71,500 pages*2.

*1 A4 LEF, Revoria Press E1136

*2 A4 LEF size, area coverage 6% at continuous printing. Reference of FUJIFILM Business Innovation test criteria

Superb, high quality print

The heart of the printer uses VCSEL* as a light source. It enables printing at an ultra-high resolution of 2400 x 2400 dpi by producing images simultaneously with 32 laser beams.

EA-Eco LGK toner for high image quality

The EA-Eco LGK toner, with extremely small particle sizes of 6.5 microns, allows the reproduction of smooth, fine gradations in photographs, uniform densities and very fine text to be achieved. It also produces easy-to-read printed text with less glare which is also easy on your eyes.

Advanced transfer unit for consistent transport speed

Designed to prevent fluctuations in paper transport speed, the stable drive speed of the transfer belt has been achieved by increasing the roll diameter, along with the automatic adjustment of contact pressure between transfer belt and drum. These measures ensure consistent transfer speeds of all paper types.

No more multifeed and mixed blank pages

The multifeed detection sensor monitors the paper flow to prevent the feeding of multiple sheets of paper. If a multifeed is detected, printing is interrupted to prevent the insertion of a blank page.

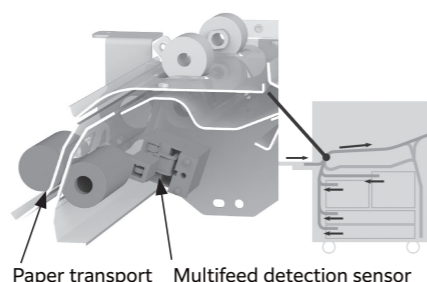

Edge enhancements to improve image quality

Higher image quality has been implemented with 'Edge Enhancement' technology that fixes the jaggedness on the edge of thin lines and text outlines, along with 'Adjust Invert Text/Line Weight' technology that fixes thickened/blurred text.

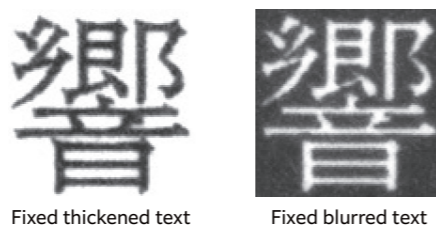

A wider variety of screening choices

Various screen settings, including an FM screen that suppresses moiré, are now available.

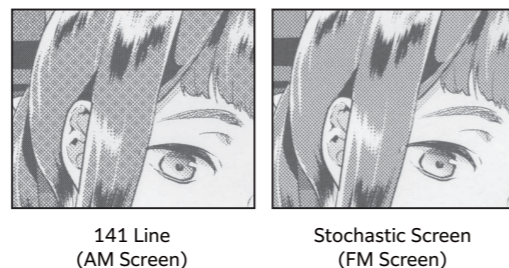

*Vertical Cavity Surface Emitting Laser

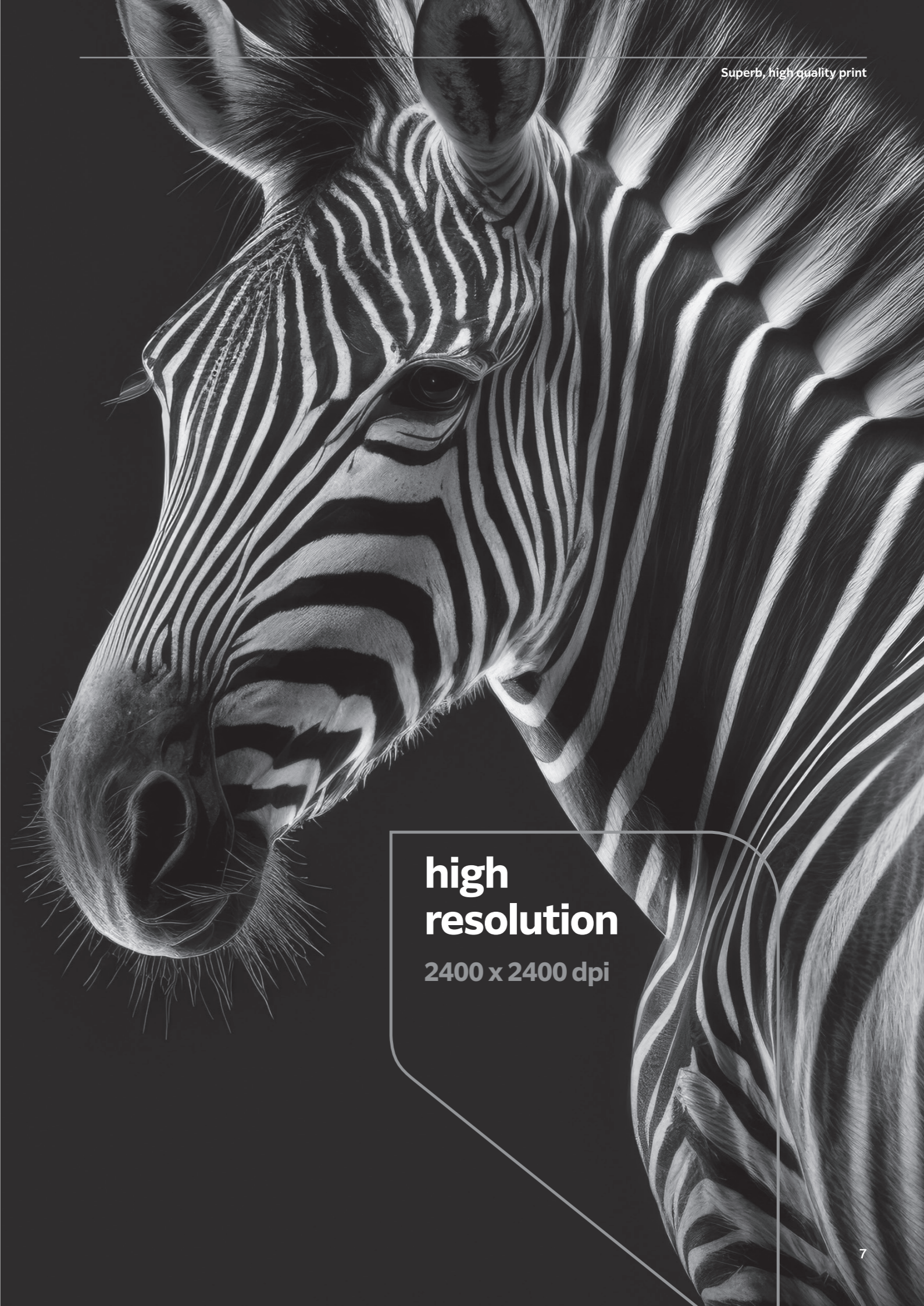

high resolution
2400 x 2400 dpi

Flexible and versatile

A wide range of paper weights, feeding options and finishing systems ensure the most versatile production.

Media handling capabilities

The E1 Series can handle a wide range of paper weights from lightweight paper of 52 gsm to heavyweight paper of 350 gsm. The upper limit of heavyweight paper has been extended thanks to the paper path design, and by employing a control mechanism that automatically switches fusing-roll pressure between two levels. Fine control has also been achieved to extend the range of supported coated and speciality papers.

Paper sizes ranging from A6 to 330.2 x 488 mm are available. Full-bleed printing on SRA3 (320 x 450 mm) sheets is also possible, to create brochures or leaflets that need to have bleed. In addition, banner printing on long paper up to 660.4 mm is also available. This means new print applications such as powerful panoramic posters are now possible.

Printing with the correct settings for each media type

Up to 100 paper types can be registered with 'Custom Paper Settings'. This allows configuration settings such as alignment, fold position and fusing temperature to be set according to the paper being used, to maximise image quality.

Flexible feeding and finishing options

A wide range of feeding and finishing options make it possible to build flexible printing systems suited to every printing operation. Supported options include cover insertion, three-sided trim, and saddle stapled booklets with square back.

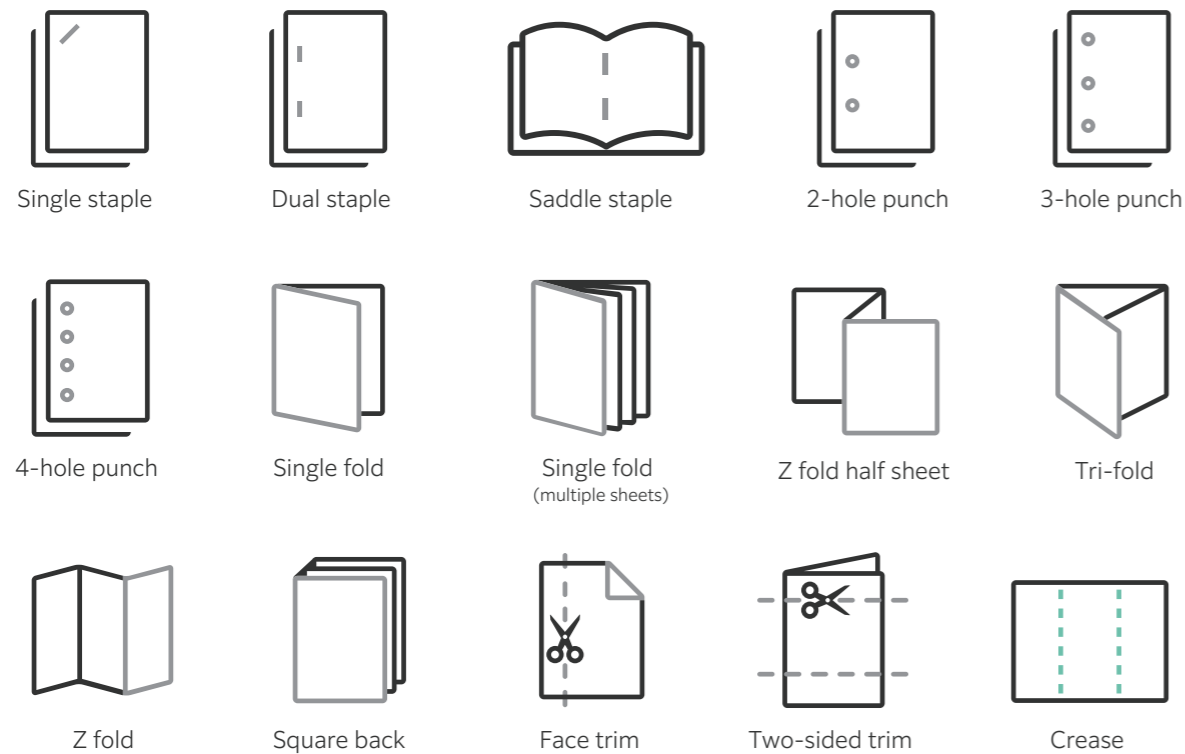
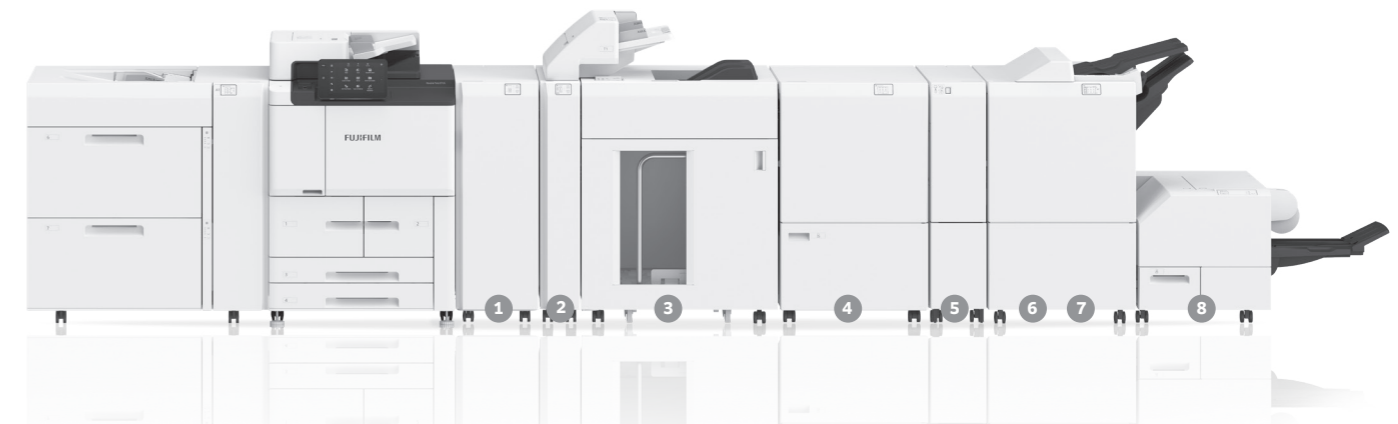

Feeding options

Up to a total of 8250 sheets can be loaded, making it possible to print continuously.



High Capacity Feeder C1-D2
Maximum A4 x 2 trays
2000 sheets x 2 trays



High Capacity Feeder B1-S*4
Maximum A3, 330.2 x 488 mm
2000 sheets x 1 tray
Air assist
**4 Not available on Revoria Press E1136.



High Capacity Feeder C3-DS*5
Maximum A3, 330.2 x 488 mm
2000 sheets x 2 trays
Air assist
**5 Not available on Revoria Press E1100.



Air Suction Feeder C1-DS*6
Maximum A3, 330.2x488 mm
2100 sheets x 2 trays +
250 sheets
Air suction
**6 Not available for Revoria Press E1100.

Finishing options

- 1 Interface Decurler Module D1
Real-time paper curl correction
 - 2 Inserter D1
Cover/sheet insertion
 - 3 High Capacity Stacker A1*7
5000-sheet offset-stacking for mass printing
Stacker cart
 - 4 Crease/Two-sided Trimmer D2*7
Two-sided trim
Crease
 - 5 Folder Unit CD2
Z fold half sheet/Tri-fold
 - 6 Finisher D6
100-sheet stapling with auto staple cutting
Hole punch*8
 - 7 Finisher D6 with Booklet Maker
100-sheet stapling with auto staple cutting
Hole punch*8
Saddle staple/Single fold
 - 8 Square Back Fold Trimmer D1*7*9
Face trim
Square back
Simple Catch Tray*10
Offset Catch Tray*10
- *7 Not available on Revoria Press E1100.
*8 Optional.
*9 Available only with Finisher D6 with Booklet Maker.
*10 Available on Revoria Press E1100.

Continuous mass printing enabled

The High Capacity Stacker A1 can accommodate up to 5000 sheets. The printed sheets are directly delivered to the stacker cart (carriage). It is useful when carrying large volumes of printouts to off-line post-processing devices.

Key specifications

	E1136	E1125	E1110	E1100
Maximum productivity A4	136 ppm	125 ppm	110 ppm	100 ppm
Maximum productivity A3	68 ppm	62 ppm	55 ppm	50 ppm
Resolution	2400 x 2400 dpi			
Paper weight	52 to 350 gsm			
Print servers	Revoria Flow PC11			

Advanced software

Advanced software and server infrastructure to support high speed, high quality production

Image data processing to maximise print engine performance

The advanced print server delivers high speeds and superb image quality by utilising image processing technologies cultivated in the development of colour production printers. High resolution and smooth screen images of 2400 x 2400 dpi are generated on the device with Fujifilm's unique HQ digital screen technologies.

In addition, our unique intermediate data format streamlines RIP processing. In conventional RIP processing, calculations take a long time due to the large data volumes. However, Fujifilm's new RIP process algorithms automatically identify objects such as text and images, and process them in the right format, greatly reducing the processing time without degrading image quality.

High speed, large volume printing of variable data

The high speed, large volume printing of personalised documents, including direct mail, bills, statements, etc., is made possible by using industry standard PPML*11, PDF/VT-1, and PDF/VT-2 languages for variable data printing.

Important print data provided by customers can be protected from data breaches by being securely erased from the print server so that the data cannot be recovered even with data recovery software. In addition, data in the printer can be encrypted or securely erased to prevent unauthorised access.

Support for Adobe® PDF Print Engine

The Adobe® PDF Print Engine directly rips PDF data. Even a PDF file with transparency or layers can be processed, and blur, drop shadow and glow effects can be used with ease.

JDF workflow

JDF, which is a communication and protocol standard in the printing industry, is supported. This means that it is possible to integrate the E1 Series printers into production workflow systems to build a hybrid workflow for both offset and digital printing.



Adobe PostScript



Adobe PDF Print Engine



*11 PPML: Personalized Print Markup Language



We're delighted with the quality and productivity of the monochrome Revoria E1."

Michael Kille, Managing Director,
Impress Print Services

Please contact your local Fujifilm partner or visit:
fujifilmprint.eu

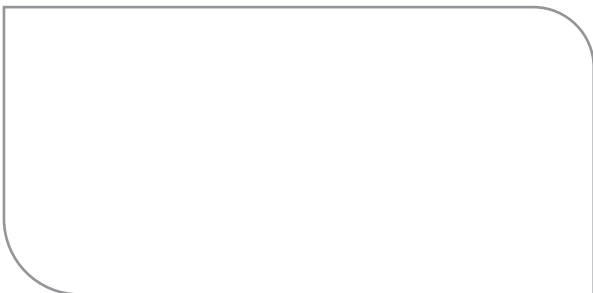

Fujifilm Print



Fujifilm Print